



# POLYWOOD

## Assembly Instructions



### Having Trouble?

If you have questions or concerns regarding assembly instructions or missing parts, please contact us at (877) 457-3284 or email [support@polywoodoutdoor.com](mailto:support@polywoodoutdoor.com)



### Share your space

We love to see where our furniture ends up — snap a pic and share it on Instagram or Facebook!  
**#polywood**



### Watch & Learn

For assembly videos and more, visit [youtube.com/polywood](https://www.youtube.com/polywood)

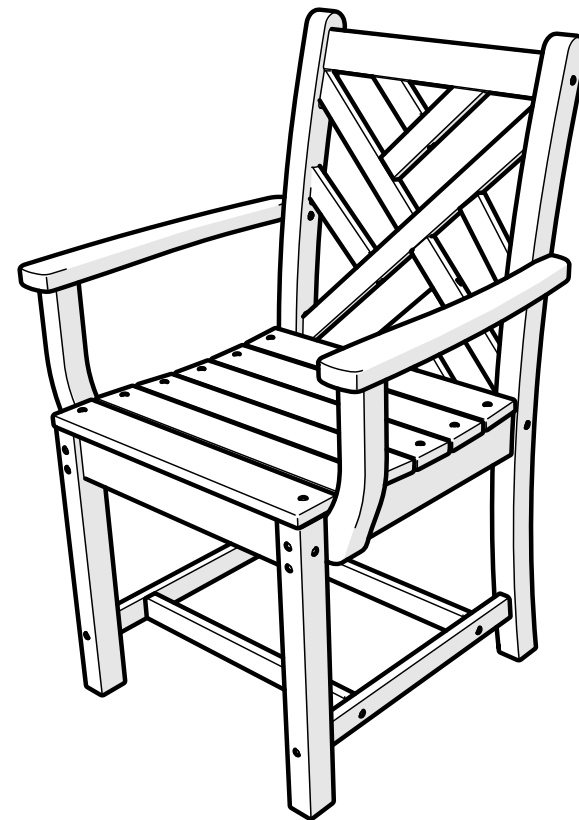

**CDD200, CDD201,  
CDD202  
Chippendale  
Arm Chair**

### 20-Year Warranty

To view our full warranty, please visit [polywoodoutdoor.com/warranty](https://polywoodoutdoor.com/warranty)

Easily register your product using one of the methods below:

**Text POLYWOOD to 71403**  
Receive a link to register online

— or —

**Register on our website**  
[register.polywoodoutdoor.com](https://register.polywoodoutdoor.com)

— or —

**Send a Picture**  
Take a photo of the icon below and text it to 71403 (US only)



### Cleaning Tips

Even POLYWOOD gets dirty — here are some ways to help keep it clean:

#### For a quick clean:

Simply wipe down with soap and water.

#### For a deeper clean:

You'll need:

- » 1/3 bleach and 2/3 water solution
- » clean cloth
- » soft bristle brush

Wipe on solution with your cloth and let it sit on the lumber for a few minutes (this will not affect the color). Then, loosen any dirt and debris that may catch in surface grooves with a soft bristle brush; hose down to rinse.

# TOOLS



4mm hex key  
(included)

# PARTS

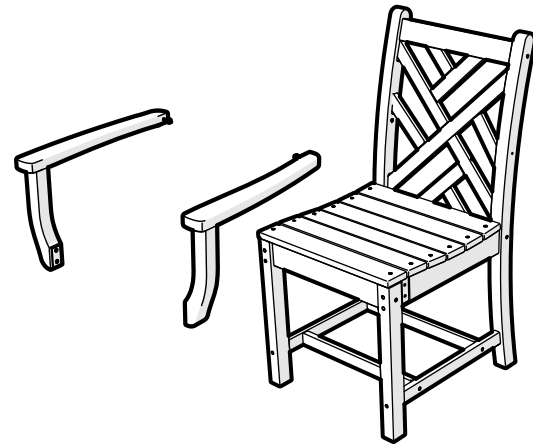

**A** x 4



1.75" Bolt — H.25-20X1.75

**x 4**

Hole Plug — HSP.312x.25

**1**

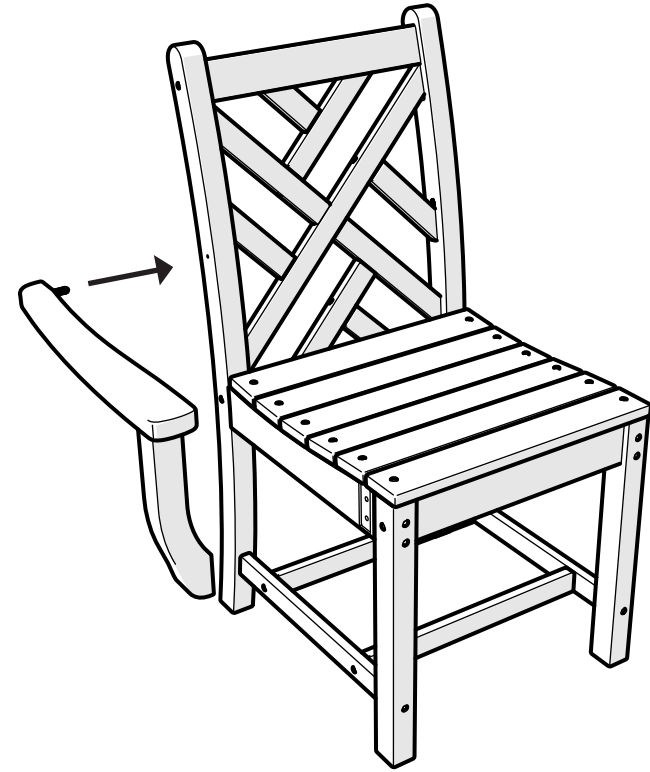

**2**

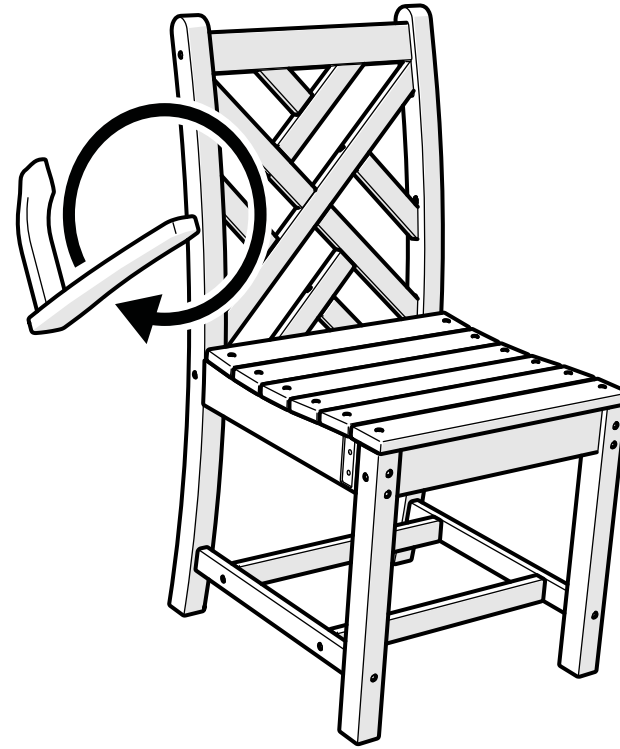

**3**

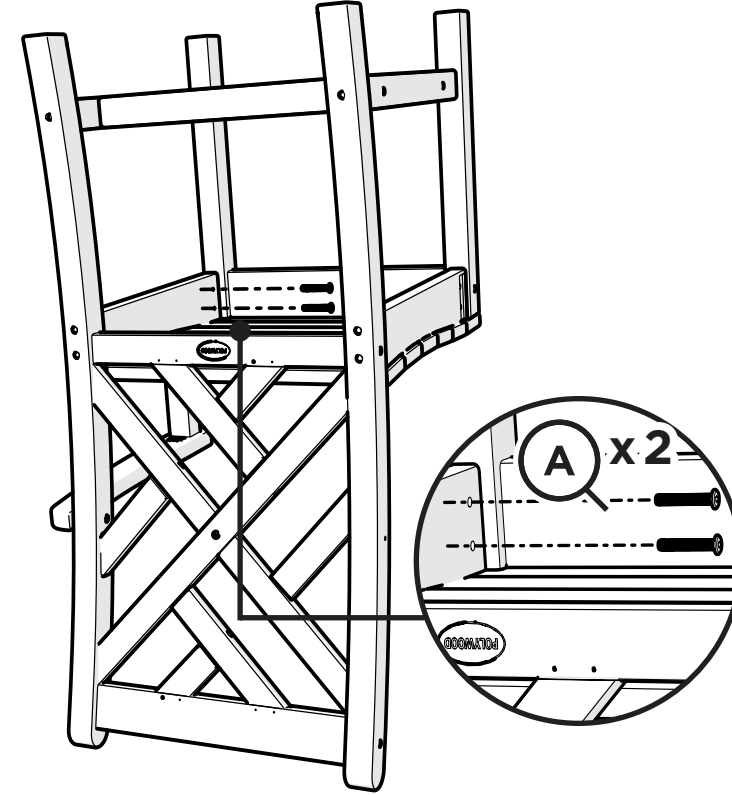

**4**

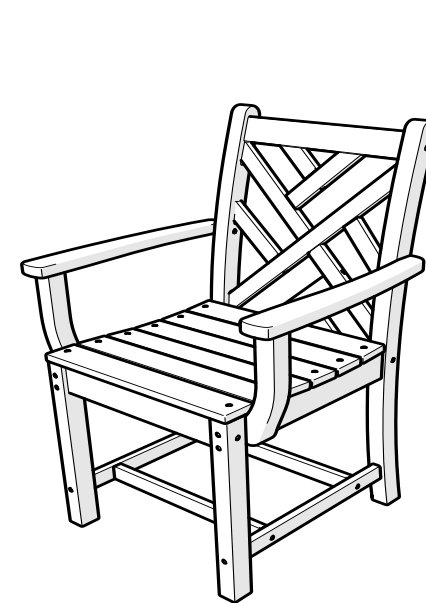
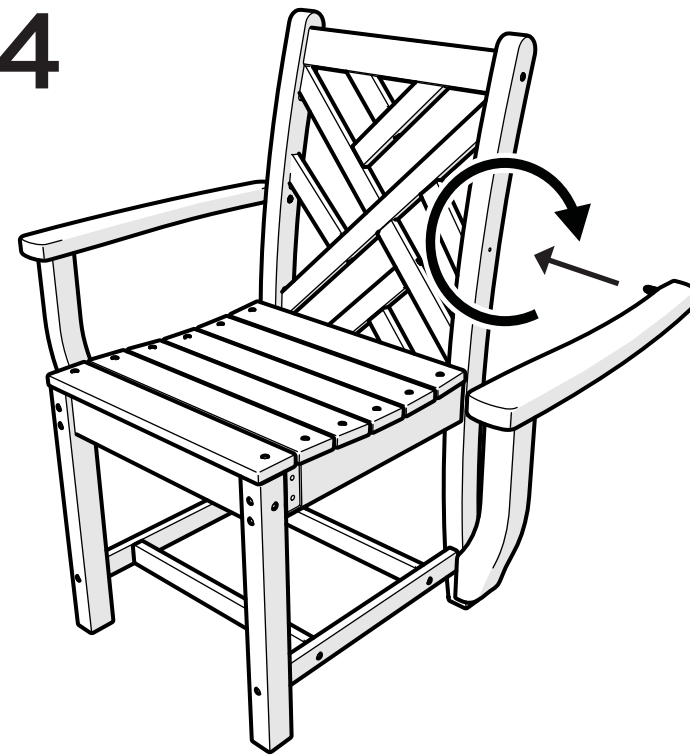

CDD200

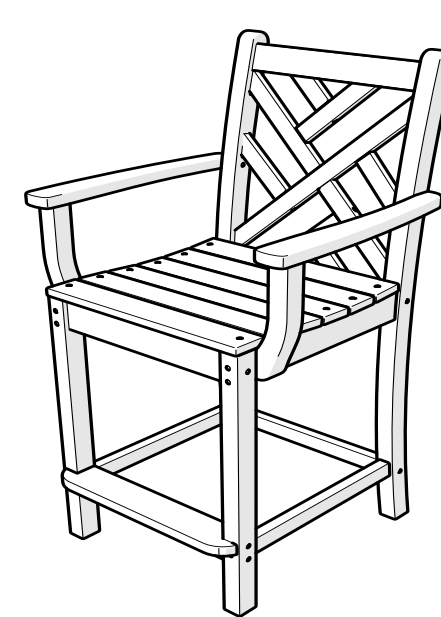

CDD201

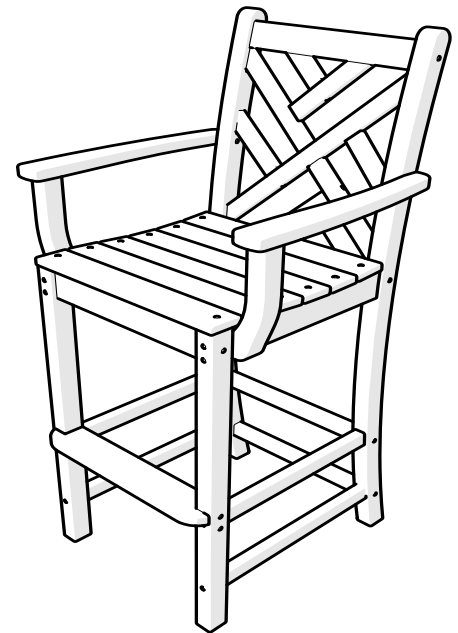

CDD202

Repeat Steps 1 Thru 3  
On Opposite Side